

THREE AUDIO POWER AMPLIFIER

The KIA8256H is 3 channel audio power amplifier for consumer applications.

This IC provides an output power of 6 watts per channel (at $V_{CC}=20V$, $f=1kHz$, $THD=0\%$, $R_L=8\Omega$)

It is suitable for power amplifier of TV and home stereo.

FEATURES :

- Built-in 3ch Amplifier.
- High Output Power : $P_{OUT}=6W(Typ.)$
($V_{CC}=20V$, $f=1kHz$, $THD=10\%$, $R_L=8\Omega$)
- Built in audio muting circuit.
- NF terminal capacitor less
: Fixed gain($G_v=34dB$), needless external capacitor.
- Protectors
Thermal shut down protection circuit
Over voltage protection circuit.
- Low Popping Noise.
- Hi THD Ratio.
- Hi Input Dynamic Range.
- Available for using same PCB layout with 2 channel IC : KIA8246H.
- Operating Supply Voltage Range : $V_{CC(oper)}=10\sim 30V.(T_a=25^\circ C)$

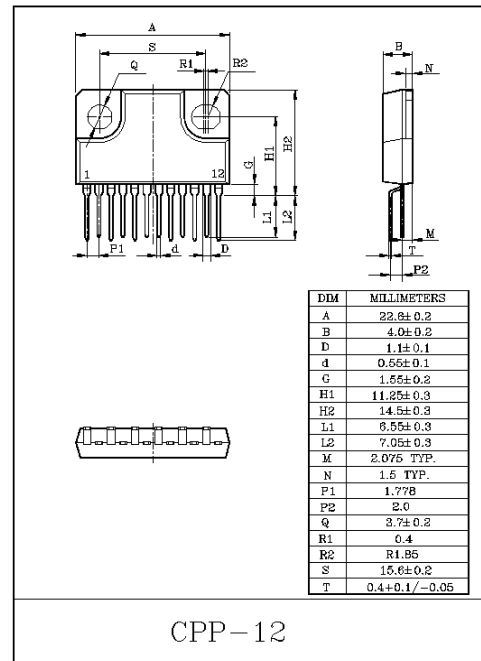

MAXIMUM RATINGS (Ta=25°C)

CHARACTERISTIC	SYMBOL	RATING	UNIT
Supply Voltage	V_{CC}	30	V
Output Current (Peak/ch)	$I_o(peak)$	2.0	A
Power Dissipation	P_D (Note)	25	W
Operating Temperature	T_{opr}	-20~75	°C
Storage Temperature	T_{stg}	-55~150	°C

(Note) Derated above $T_a=25^\circ C$ in the proportion of 200mW/°C for KIA8256H.

KIA8256H

ELECTRICAL CHARACTERISTICS

(Unless otherwise specified, $V_{CC}=20V$, $R_g=620\Omega$, $R_L=8\Omega$, $f=1kHz$, $T_a=25^\circ C$)

CHARACTERISTIC	SYMBOL	TEST CIRCUIT	TEST CONDITION	MIN.	TYP.	MAX.	UNIT
Quiescent Current	I_{CCQ}	-	$V_{IN}=0$	65	100	180	mA
Output Power	$P_{OUT(1)}$	-	THD=10%	5	6	-	W
	$P_{OUT(2)}$	-	THD=1%	-	4.5	-	
Total Harmonic Distortion	THD(1)	-	$P_{OUT}=2W$	-	0.04	0.2	%
	THD(2)	-	$P_{OUT}=2W$, $f=10kHz$	-	0.1	0.6	
Voltage Gain	G_V	-	$V_{OUT}=0.775V_{rms}$	32.5	34	35.5	dB
Input Resistance	R_{IN}	-	-	-	34	-	k Ω
Ripple Rejection Ratio	R.R	-	$f=100Hz$, $V_{ripple}=0.775V_{rms}$	-40	-47	-	dB
Output Noise Voltage	V_{NO}	-	$R_g=10k\Omega$, $BW=20Hz\sim 20kHz$	-	0.14	0.3	mV $_{rms}$
Cross Talk	C.T.	-	$V_{OUT}=0.775V_{rms}$	-	-60	-	dB
Mute Control Voltage	$V_{th(ON)}$	-	MUTE ON	3.1	-	V_{CC}	V
	$V_{th(OFF)}$	-	MUTE OFF	0	-	2.5	
Mute attenuation Level	ATT	-	$V_{out}=0.775V_{rms}\rightarrow MUTE$	-52	-60	-	dB

BLOCK DIAGRAM

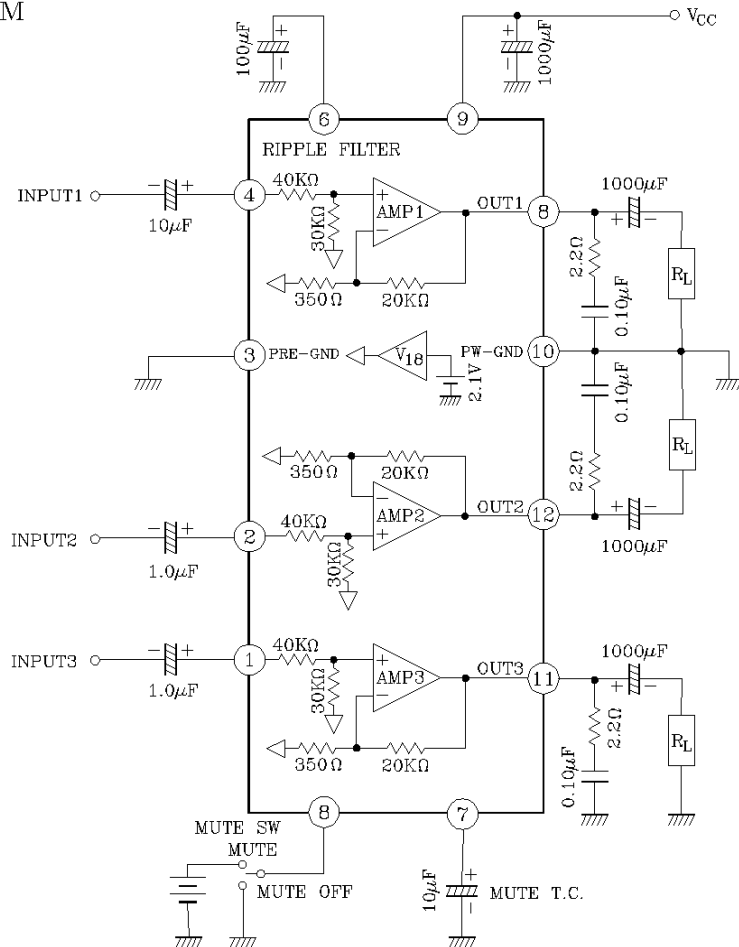

KIA8256H

EXPLANATION OF TERMINALS

TERMINAL No.	SYMBOL	FUNCTION	EQUIVALENT CIRCUIT
1	IN3	INPUT	
2	IN2		
4	IN1		
3	PRE-GND	GND terminal	
5	MUTE.S.W	MUTE control terminal	
7	MUTE.T.C		
6	RF	Ripple filter	
8	OUT1	Output	
11	OUT3		
12	OUT2		
9	VCC	Supply voltage terminal	-
10	PW-GND	GND terminal	-

KIA8256H

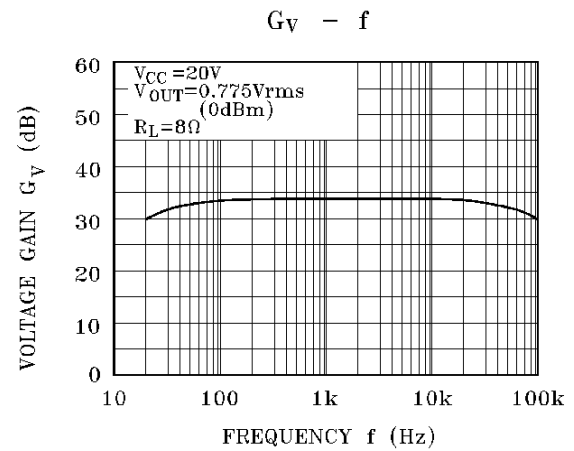
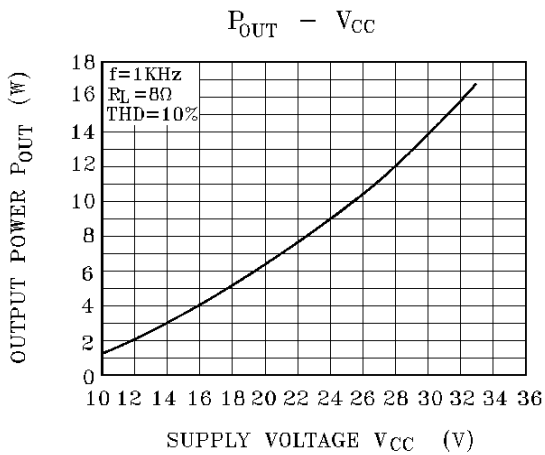
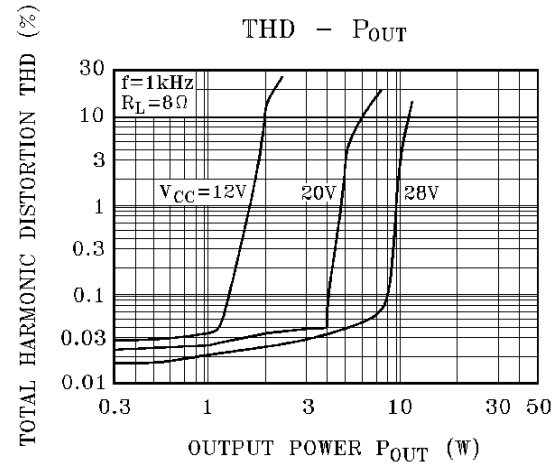
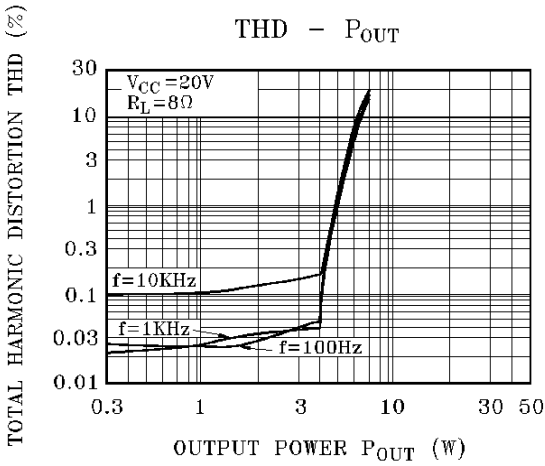
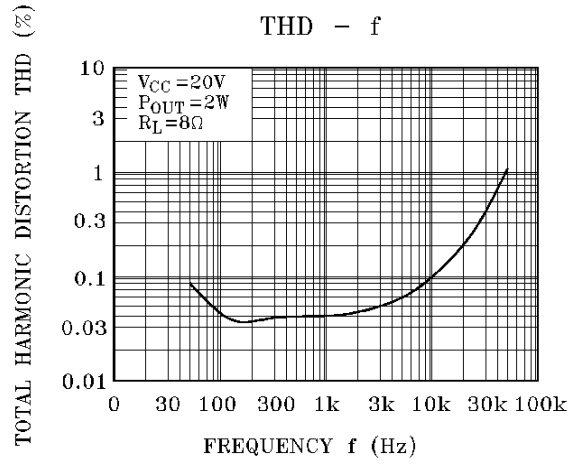
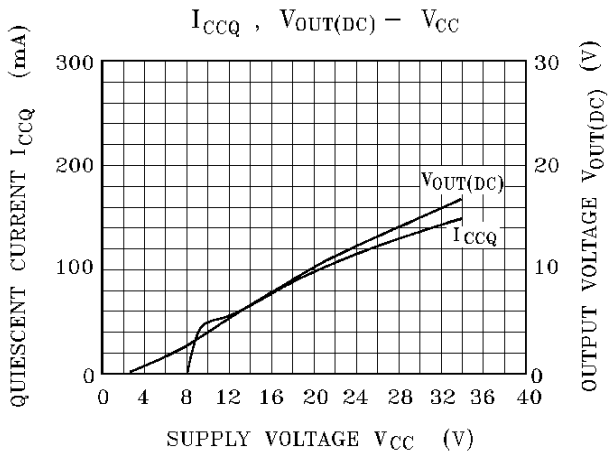

KIA8256H

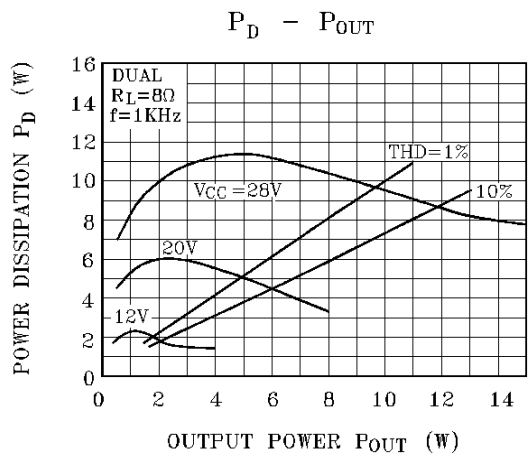
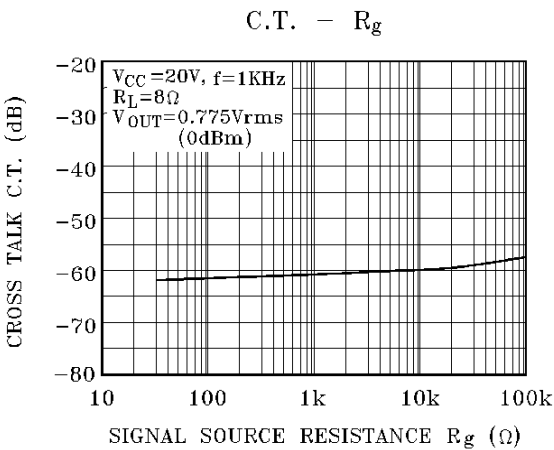
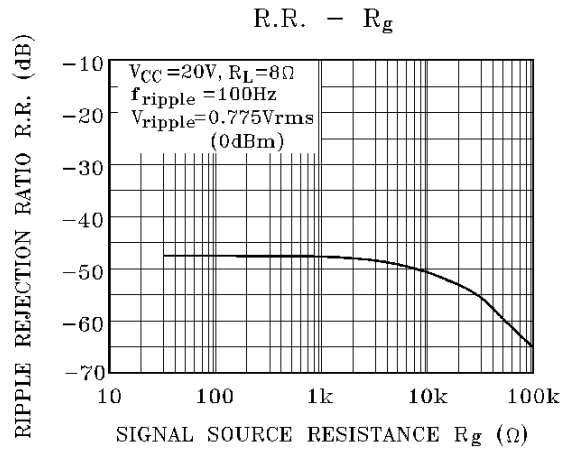
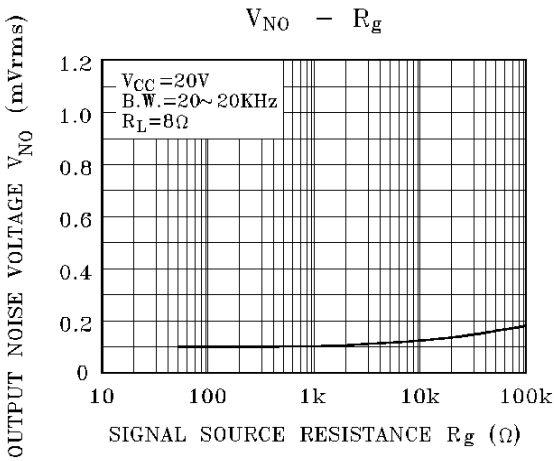
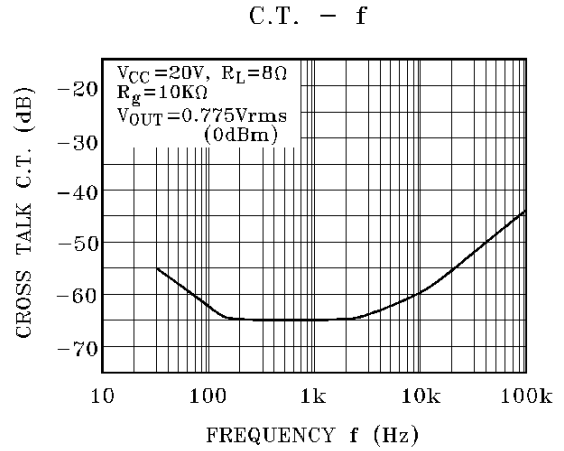
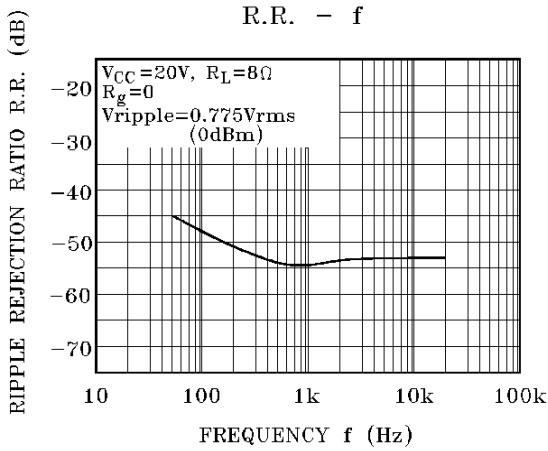

KIA8256H

